

PROJECT	
TYPE	
SPECIFIER	
QUANTITY	
DATE	

ETEREA PORTABLE

E9B151- -

base number	Color	Finish
	Temperature	Options

- To build a product code in our configurator select the specify button on the base model # product page
- To build a manual product code on this datasheet choose from the options listed below in blue font and add the suffix to the base model #

GENERAL

Series: Eterea
Brand: Platek
Division: Exterior
Mounting Type: Portable
Mounting Location: Floor
Subcategory: Floor

PHYSICAL

Shape: Rectangle
Length (mm): 216
Length (in): 8 1/2
Width (mm): 216
Width (in): 8 1/2
Height (mm): 455
Height (in): 17 15/16
Light Distribution: Direct
Weight (kg): 6.3
Weight (lbs): 13.8
Diffuser: White Tempered Glass
Fixture Finish: WHI / ANT / COR
Holder Finish: Chrome
Fixture Material: Stainless Steel
Cable Details: Supplied with one power supply cable 5m in length
Upon Request: Bolt Down

ELECTRICAL

Lamp Type: LED
Input Wattage (W): 17.5
Total Output Wattage (W): 16.5
Dimming: Non-Dimmable
Input Voltage (V): 120

LED

Color Temperature (°K): 3000 / 4000
Max. Delivered Lumen (lm): 735 / 765
Nominal Lumen (lm): 1550 / 1612
CRI: >80 CRI
Lamp Life (hrs): 60000

OPTICAL

Optic°: 114

RATINGS AND CERTIFICATIONS

Certified By: Certified for North American Standards
IP rating: IP65
IK Rating: IK08
Bug Rating: B0 U0 G0
Upon Request: Higher Maximum Ambient Temperature



ETEREA PORTABLE

E9B151-

PROJECT

TYPE

SPECIFIER

QUANTITY

DATE



E

ETEREA PORTABLE

E9B224-

base number Finish
Options

- To build a product code in our configurator select the specify button on the base model # product page
- To build a manual product code on this datasheet choose from the options listed below in blue font and add the suffix to the base model #

GENERAL

Series: Eterea
Brand: Platek
Division: Exterior
Mounting Type: Portable
Mounting Location: Table
Subcategory: Battery Operated

PHYSICAL

Shape: Rectangle
Length (mm): 150
Length (in): 5 ⁷/₈
Width (mm): 150
Width (in): 5 ⁷/₈
Height (mm): 300
Height (in): 11 ¹³/₁₆
Light Distribution: Direct
Weight (kg): 1.8
Weight (lbs): 4
Screws: No visible screws
Diffuser: Frosted Methacrylate
Fixture Finish: [ANT](#) / [BLK](#) / [BRZ](#) / [COR](#) / [RSB](#) / [WHI](#)
Fixture Material: Stainless Steel
Cable Details: Supplied with one Micro USB power supply cable 1.2m in length
Upon Request: Bolt Down

ELECTRICAL

Lamp Type: LED
Input Wattage (W): 4.5
Total Output Wattage (W): 4.5
Dimming: Non-Dimmable
Input Voltage (V): 120

LED

Number of LEDs: 1
Color Temperature (°K): 3000
Max. Delivered Lumen (lm): 275
Nominal Lumen (lm): 450
CRI: >90 CRI
Lamp Life (hrs): 60000

OPTICAL

Optic°: 100

RATINGS AND CERTIFICATIONS

Certified By: Certified for North American Standards
IP rating: IP65
IK Rating: IK07
Bug Rating: B0 U0 G0
Upon Request: Higher Maximum Ambient Temperature

PROJECT _____
TYPE _____
SPECIFIER _____
QUANTITY _____
DATE _____

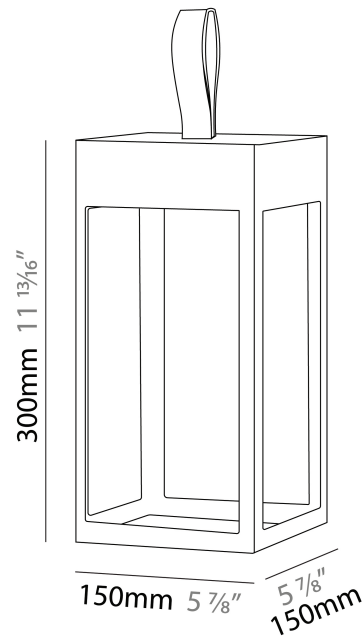

ETEREA PORTABLE

E9B224-

PROJECT

TYPE

SPECIFIER

QUANTITY

DATE

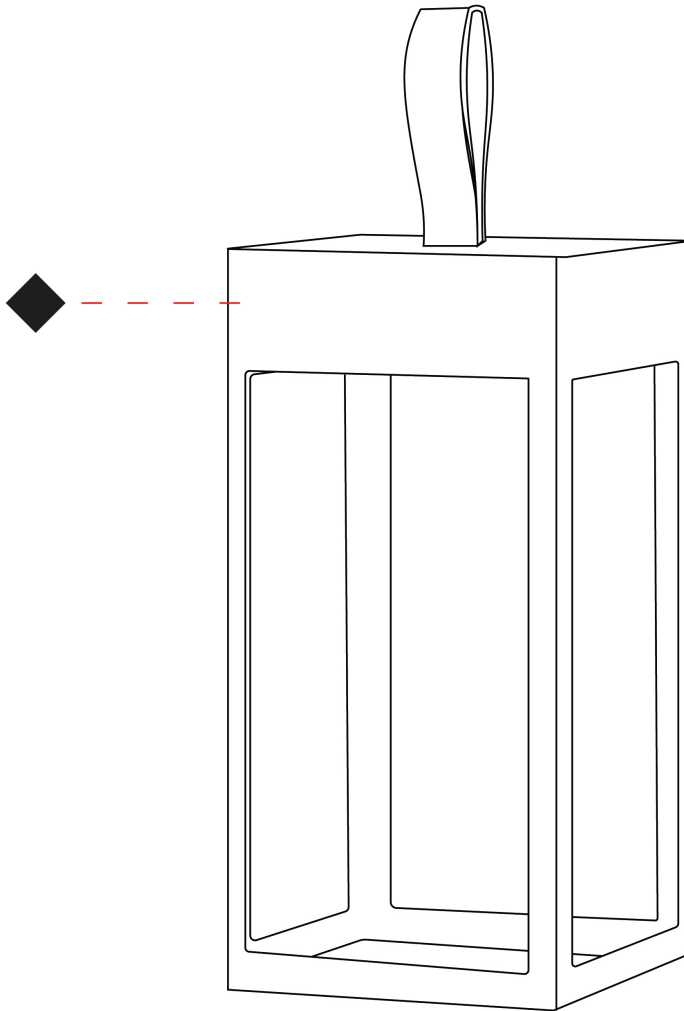

E

PROJECT _____
 TYPE _____
 SPECIFIER _____
 QUANTITY _____
 DATE _____

ETEREA PORTABLE

E9B268-

base number _____
 Finish _____
 Options _____

- To build a product code in our configurator select the specify button on the base model # product page
- To build a manual product code on this datasheet choose from the options listed below in blue font and add the suffix to the base model #

GENERAL

Series: Eterea _____
 Brand: Platek _____
 Division: Exterior _____
 Mounting Type: Portable _____
 Mounting Location: Table _____
 Subcategory: Battery Operated _____

PHYSICAL

Shape: Rectangle _____
 Length (mm): 216 _____
 Length (in): 8 ½ _____
 Width (mm): 216 _____
 Width (in): 8 ½ _____
 Height (mm): 455 _____
 Height (in): 17 15/16 _____
 Light Distribution: Direct _____
 Weight (kg): 2.80 _____
 Weight (lbs): 6.17 _____
 Screws: No visible screws _____
 Diffuser: Frosted Methacrylate _____
 Fixture Finish: [ANT](#) / [BLK](#) / [BRZ](#) / [COR](#) / [RSB](#) / [WHI](#) _____
 Fixture Material: Stainless Steel _____
 Cable Details: Supplied with one Micro USB power supply cable 1.2m in length _____
 Upon Request: Bolt Down _____

ELECTRICAL

Lamp Type: LED _____
 Input Wattage (W): 4.5 _____
 Total Output Wattage (W): 4.5 _____
 Dimming: Non-Dimmable _____
 Input Voltage (V): 120 _____

LED

Number of LEDs: 1 _____
 Color Temperature (°K): 3000 _____
 Max. Delivered Lumen (lm): 275 _____
 Nominal Lumen (lm): 450 _____
 CRI: >90 CRI _____
 Lamp Life (hrs): 60000 _____

OPTICAL

Optic°: 100 _____

RATINGS AND CERTIFICATIONS

Certified By: Certified for North American Standards _____
 IP rating: IP65 _____
 IK Rating: IK07 _____
 Bug Rating: B0 U0 G0 _____
 Upon Request: Higher Maximum Ambient Temperature _____

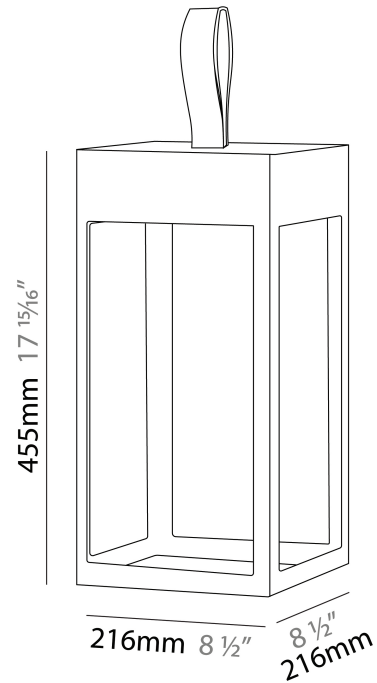

ETEREA PORTABLE

E9B268-

PROJECT

TYPE

SPECIFIER

QUANTITY

DATE



E

PROJECT	_____
TYPE	_____
SPECIFIER	_____
QUANTITY	_____
DATE	_____

ETEREA SURFACE

E9W609- _____ - _____
 base number Color Finish
 Temperature Options

- To build a product code in our configurator select the specify button on the base model # product page
- To build a manual product code on this datasheet choose from the options listed below in blue font and add the suffix to the base model #

GENERAL

Series: Eterea
 Brand: Platek
 Division: Exterior
 Mounting Type: Surface
 Mounting Location: Wall
 Subcategory: Wall Effect

PHYSICAL

Shape: Rectangle
 Length (mm): 216
 Length (in): 8 1/2
 Width (mm): 216
 Width (in): 8 1/2
 Height (mm): 455
 Height (in): 17 15/16
 Light Distribution: Direct
 Weight (kg): 6.1
 Weight (lbs): 13.4
 Diffuser: White Tempered Glass
 Fixture Finish: WHI / ANT / COR
 Holder Finish: Chrome
 Fixture Material: Stainless Steel
 Cable Details: Supplied with one power supply cable 5m in length

ELECTRICAL

Lamp Type: LED
 Input Wattage (W): 17.5
 Total Output Wattage (W): 16.5
 Dimming: Electronic Low Voltage Dimming to 20%
 Input Voltage (V): 120

LED

Color Temperature (°K): 3000 / 4000
 Max. Delivered Lumen (lm): 735 / 765
 Nominal Lumen (lm): 1550 / 1610
 CRI: >80 CRI
 Lamp Life (hrs): 60000

OPTICAL

Optic°: 114
 Beam Angle: Wide

RATINGS AND CERTIFICATIONS

Certified By: Certified for North American Standards
 IP rating: IP65
 IK Rating: IK08
 Bug Rating: B0 U0 G0
 Upon Request: Higher Maximum Ambient Temperature

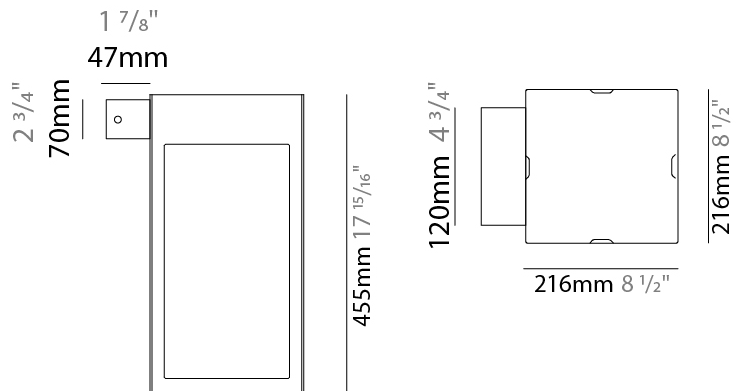

E9W609-

PROJECT

TYPE

SPECIFIER

QUANTITY

DATE

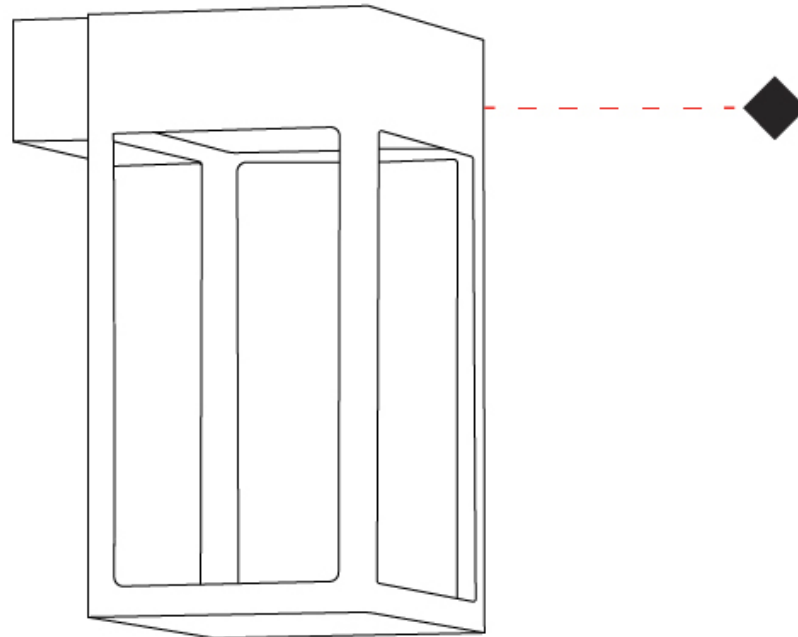

PROJECT	_____
TYPE	_____
SPECIFIER	_____
QUANTITY	_____
DATE	_____

Fixture Finish

White - WHI



Anthracite - ANT

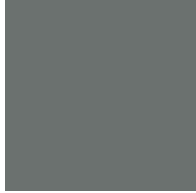

Corten - COR



Black - BLK



Bronze - BRZ

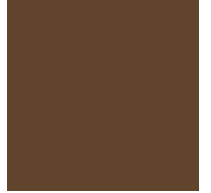

Holder Finish

Digital: Not all screens are calibrated the same, and therefore, colors will appear differently between screens.

Physical: When texture is involved, there will be variations in color, character and tone within a product series and between product families.



PROJECT	
TYPE	
SPECIFIER	
QUANTITY	
DATE	

LEGEND

floor-mounted	pivotal	special LED (upon request) RGB, RGBW, tunable, gold+, meat+, art+, fashion+
wall and ceiling: recessed and surface mounted	rotating	warm dim / natural dimming LED
ceiling-mounted and wall-mounted	illuminate tilted	rechargeable battery powered
wall-mounted	color of suspension cable	fixture with natural vivid LED (upon request)
omni-directional light distribution	length of suspension cable	color rendering index
direct light distribution	reflector degree selection	color temperature
direct/indirect light distribution	super spot	lumen (luminous flux)
indirect light distribution	lens	efficacy (lumens per watt)
asymmetric light distribution	lens pack	Unified Glare Rating (UGR) range from 5-40
aura light distribution	shine ring	marine grade (AISI 316 stainless steel)
round wall or ceiling cut-out	integrated shine ring with diffuser	walk on
square wall or ceiling cut-out	free individual colors 01-29	drive on
the supplied jig specifies the cutout dimensions	individual colors: 00 (free of charge), 01-25 (extra charge)	Dark Sky Compliance
minimum distance (meters) lamp - object	luminaire part to be colored (F1)	Americans with Disabilities Act (less than 4" off the wall located between 27"-84" from floor)
recessed depth	luminaire part to be colored (F2)	lamp protected against explosion
ceiling thickness in mm	luminaire part to be colored (F3)	blown glass using traditional methods by master glass blower
ceiling thickness selection	luminaire part to be colored (F4)	acoustic material
dimmable DP (phase), DV (0-10V), DD (dali), DS (step-dim)	luminaire part to be colored (F5)	protection class I, protection insulation
included or excluded LED driver/transformer/control gear	color of 3-circuit adaptor	protection class II, protection insulation
separately switchable	indirect diffuser	ETL Certified to UL and CSA Standards
sensor	direct diffuser	UL Certified to UL and CSA Standards
remote control	ball-proof (upon request)	CSA Certified to UL and CSA Standards
available upon request	accessory	Certified for North American Standards

IP RATING

IP20	protected against ingress of solid bodies greater than 12.5mm (finger)
IP33	protected against ingress of solid bodies greater than 2.5mm protected against sprays of water up to 60 degrees from the vertical (rain)
IP40	protected against ingress of solid bodies greater than 1mm (wire) no protection against the ingress of moisture
IP43	protected against ingress of solid bodies greater than 1mm (wire) protected against sprays of water up to 60 degrees from the vertical (rain)
IP44	protected against ingress of solid bodies greater than 1mm (wire) protected against water splashed from all directions
IP54	protected against limited ingress of dust (wet rooms/covered outdoor areas) protected against water splashed from all directions
IP65	protected against ingress of dust protected against jets of water
IP66	protected against ingress of dust protected against powerful jets of water or heavy seas
IP67	protected against ingress of dust protected against immersion of water between 15cm - 1m for 30 minutes
IP68	protected against ingress of dust protected against immersion of water under pressure for long periods

IK RATING

IK01	protected against 0.14 joules impact (equivalent to 0.25kg mass dropped from 56mm above the surface)
IK02	protected against 0.2 joules impact (equivalent to 0.25kg mass dropped from 80mm above the surface)
IK03	protected against 0.35 joules impact (equivalent to 0.25kg mass dropped from 140mm above the surface)
IK04	protected against 0.5 joules impact (equivalent to 0.25kg mass dropped from 200mm above the surface)
IK05	protected against 0.7 joules impact (equivalent to 0.25kg mass dropped from 280mm above the surface)
IK06	protected against 1 joules impact (equivalent to 0.25kg mass dropped from 400mm above the surface)
IK07	protected against 2 joules impact (equivalent to 0.5kg mass dropped from 400mm above the surface)
IK08	protected against 5 joules impact (equivalent to 1.7kg mass dropped from 300mm above the surface)
IK09	protected against 10 joules impact (equivalent to 5.0kg mass dropped from 200mm above the surface)
IK10	protected against 20 joules impact (equivalent to 5.0kg mass dropped from 400mm above the surface)